

SmartLINK Module Ei3000MRF

for Mains Powered Multi-Sensor Fire / Smoke / Heat /
CO Alarms - Ei3000 Series

Instruction Manual

Read and retain carefully for as long as the product is being used. It contains vital information on the operation and installation of your Alarm. The leaflet should be regarded as part of the product.

If you are just installing the unit, the leaflet **MUST** be given to the householder. The leaflet is to be given to any subsequent user.



Contents

1. Introduction	4
2. Installation and House Coding	6
3. System Installations	13
4. Additional Features	18
5. Troubleshooting and Indicator summary tables	22
6. Testing the System	29
7. Interconnected CO Alarms and Smoke Alarms	32
8. SmartLINK Troubleshooting	34
9. Technical Specifications	36
10. Guarantee	38
11. Limitations of Radio Communications	40

1

Introduction

The Ei3000MRF SmartLINK Module is the next generation RF module from Ei Electronics designed to fit in the Ei3000 series, Easi-fit mains powered Alarms.

The primary function of the Ei3000MRF is to wirelessly interconnect all Ei Electronics Alarms in a system by means of an RF signal i.e. when one Alarm senses a fire event, the Ei3000MRF module fitted to that Alarm will transmit an RF signal that will activate the sounders in all other RF Alarms in the system.

Other features include:

- Remote House coding, to reduce installation time for Alarm additions to existing sites.
- Data Extraction, to collect important information on the Alarm status, including activations, tests, CO levels, faults etc.
- Monitoring (buddy system) where the strongest RF signal paths are selected between a pair of devices as a means to monitor the RF connection.
- Live Monitoring, via the Ei1000G Gateway and the proprietary Cloud portal, to track Alarm activations, tampering, faults etc. and provide for planned maintenance.

The Ei3000MRF module is simply plugged into the rear of the base of an Ei3000 series Alarm. RF communication via this module eliminates the need to install long interconnect wires between all the Alarms on different floors in different rooms. The Ei3000MRF is powered from the Alarm it is connected to.

The module also has "multiple repeater" transmission – this provides multiple signal paths to create a robust RF 'mesh' system and also increase the RF range.

2

Installation and House Coding

N.B Disconnect Mains Before Alarm Head Removal

After disconnecting the mains power supply, it is now safe to remove the Alarm from its base. Using a screwdriver, insert into the removal slot on the side of the Alarm.

Push the lower half of the Alarm away from the screwdriver, in the direction of the arrow on the cover (see Figure 1 below).

CAUTION: The existing hard-wired interconnection may need to be disconnected at this point (refer to the Installation section in the Alarm instruction manual). If a hard-wired connection and an RF connection exist between the **SAME** two Alarms, a continuous Alarm loop signal may occur.

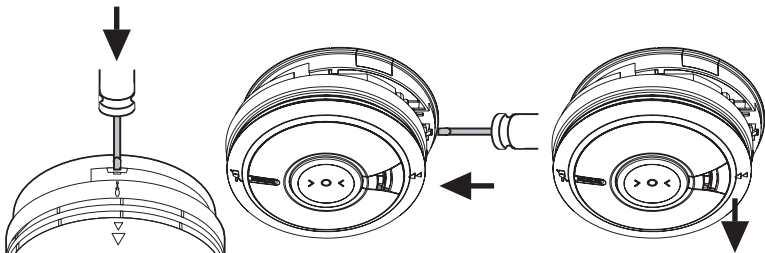

Figure 1

Fitting the Ei3000MRF Module

To fit the Ei3000MRF Module, first hold the flexible antenna and guide it into its designated hole in the rear of the unit until about 2/3 of its length is inserted (Fig. 2a). Then, hold the module housing (Fig. 2b) and plug it into the Alarm, being careful to align the pins and keeping them perpendicular to the base as the module is inserted (Fig. 2c). Ensure the module is fully home, by checking that it is flush with the surrounding Alarm housing (Fig. 2d).

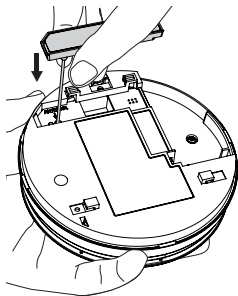

Figure 2a

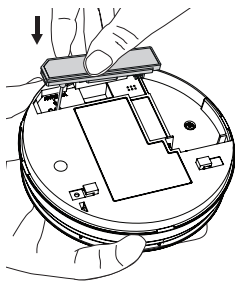

Figure 2b

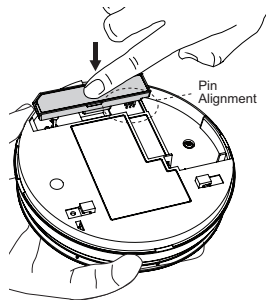

Figure 2c

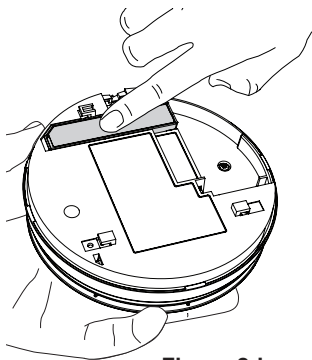

Figure 2d

House Coding the Unit

Re-connect the Alarm to the base. Switch back on the mains power. Check for the green LED on the Alarm cover. Power supply to the Ei3000MRF will be confirmed by an initial flash of the red, blue and green LED on the side of the unit (see Fig 3).

Using a screwdriver, press and hold the House Code button on the side of the unit until the blue light illuminates (see Fig 4).

Immediately release the button, the blue light will flash rapidly and then stop.

The flashing will repeat every 5 seconds thereafter. Repeat this procedure for all Alarms in the system.

Check to ensure all RF devices have been successfully House Coded. This can be done by counting the number of blue flashes on each RF Module. The number of flashes should correspond to the number of RF devices in the system. (i.e. 4 flashes if there are 4 devices in the system). **Note:** If an Ei3028 Alarm is included in the system, there will be an extra blue flash (this corresponds to the 2 independent sensors in the Alarm head). e.g with 4 RF devices in a system, one of which is an Ei3028 you would expect 5 blue flashes during the housecode process and so on.

N.B. We recommend, for ease of installation and RF communication, that up to 12 RF devices can be installed in any one RF coded system. Please contact us for further advise if additional RF devices are required.

blue, red & green LED

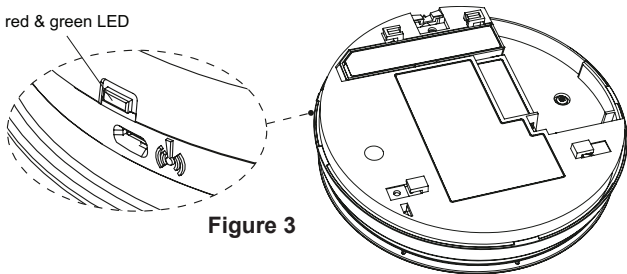

Figure 3

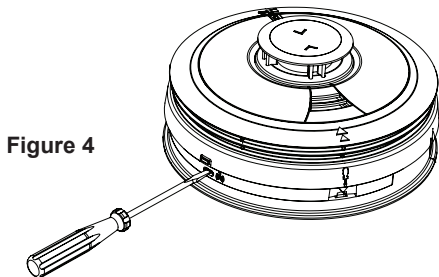

Figure 4

You can exit this mode by pressing the House Code button on one of the RF Alarms. Keep the button pressed until the blue light comes on solid and then release.

The Alarm will now send a signal to all the other RF devices in the system to exit House Code. Alternatively, the RF Alarms will automatically exit the House Code mode after 30 minutes. To check the system, press the test button on any Alarm. After a few seconds all Alarms should now sound. All Alarms in the system should be checked similarly.

Caution: Do not House Code another group (e.g. adjacent apartment) until the current House Code has been completed.

Factory Reset

Sometimes in order to resolve an RF communication issue it may be necessary to reset (factory reset) and House Code the system again. To do so, press and hold the House Code button until you see a flashing blue light on the Alarm cover (approx. 7 seconds), release immediately. Repeat this procedure on all Alarms.

Removing the Ei3000MRF Module

If it is necessary to remove or replace an RF Module already fitted to an Alarm, it can be taken out by firstly using your index finger to lift it by 5 to 6mm to release the connection pins (Fig. 5a), repeat this process on the opposite end to release the antenna (Fig. 5b), after which the module can be fully removed from the Alarm by lifting it away while keeping the pins perpendicular to the Alarm (Fig. 5c).

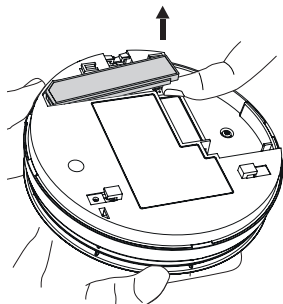

Figure 5a

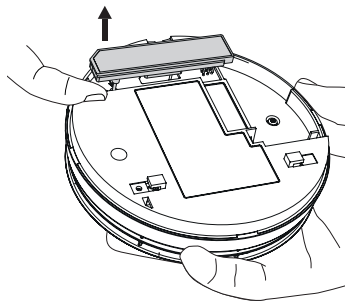

Figure 5b

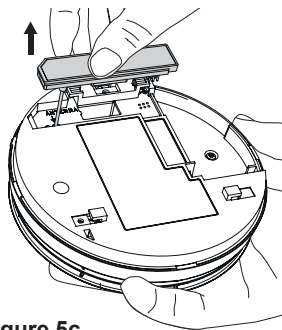

Figure 5c

3

System Installations

Mixed Hardwired Interconnect and Wireless Interconnect (Hybrid) System

Ei3000 Series Alarms are also equipped to work in a hybrid system. A hybrid system is a combination of hardwired interconnected and RF interconnected Alarms and devices. Hybrid systems can be very flexible and allow extended fire and/or CO protection with minimum installation disruption.

Hybrid Systems should not be installed where specific alarm type (Fire or CO) indication is critical - for example, if required to trigger switching equipment depending on the alarm type detected. This is because the hardwire interconnect line does not communicate the alarm type, whereas the RF interconnection does. Therefore, we recommend using RF only interconnected Ei3000 series Alarms where specific alarm type indication is required.

Examples of various RF and Hardwired Systems

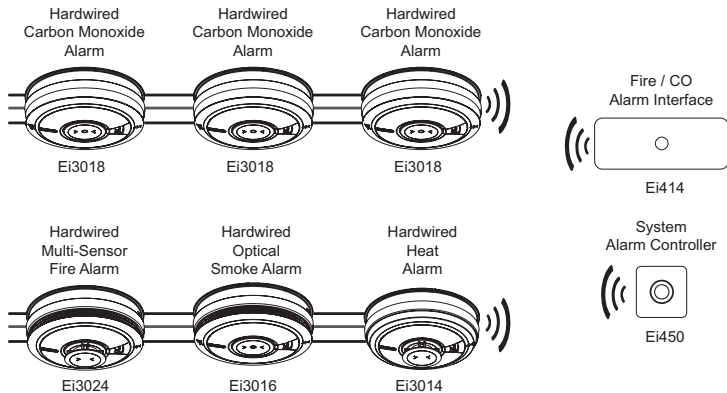

The hardwired interconnected sections of a hybrid system should be separated into CO only Alarms and Fire, Smoke and Heat Alarms, to ensure that the alarm type is indicated correctly to the RF network during activation

RF Heat &
Carbon Monoxide
Alarm

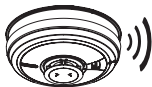

Ei3028

RF
Multi-Sensor
Fire Alarm



Ei3024

RF
Carbon Monoxide
Alarm



Ei3018

RF
Optical
Smoke Alarm



Ei3016

RF
Heat
Alarm



Ei3014

Fire / CO
Alarm Interface

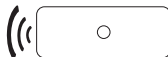

Ei414

System
Alarm Controller



Ei450

The RF network can consist of a mixture of
Fire, Smoke, Heat and/or CO Alarm types

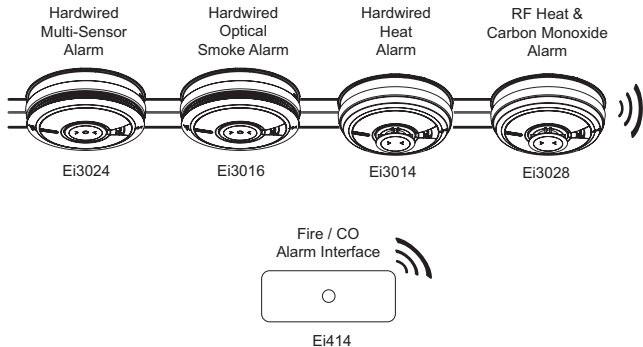

If an Ei3028 Heat and CO Alarm is required on a hardwired section, it should be fitted to a Fire, Smoke and Heat only section, one per section and that Ei3028 should also be the section's link to the RF network of the hybrid system. This ensures that the RF Fire alarm message can be transmitted if any device on the hardwire circuit is activated and the RF CO Alarm message if the Ei3028 detects dangerous levels of CO

4

Additional Features

The Ei3000MRF SmartLINK Module provides a range of exciting new additional features:

1. Remote House Coding (if you want to add or replace an Alarm to an installed system)

If it is necessary to extend an RF system or you find that you want to add an extra Alarm to a system you can now do so quite simply via the 'Remote House Coding' feature. Firstly using a screwdriver, press and hold the House Code button of one of the previously installed Alarms until you see all colours flashing - red, blue, green (typically takes about 8 seconds) and then release. This Alarm will now send an RF message to all the previously installed (compatible) devices to re-enter House Code mode. Similarly, install and put the new Alarm you wish to add to the system into House Code mode (see "Installation and House Coding" section). As before, allow sufficient time so that all Alarms are now house coded correctly (this can be confirmed by counting the number of flashes on each Alarm). You can then exit House Code mode manually or let it exit automatically after 30 minutes. (N.B. for this feature to work all devices in the system must be SmartLINK or RadioLINK+).

2. Data Extraction

The Ei3000MRF SmartLINK Module allows for the extraction of certain information from an Ei3000 Series Alarm, using an Ei Electronics download device. Once the system has been set up, information can be accessed from within or outside a property (within RF range) if access is an issue. This data is displayed as an event log and contains very useful information about any recorded events in the history of the Alarm such as: Fire Events, Alarm Head removals, Button Tests, CO levels and so on.

Event logs can be retrieved as many times as necessary and can be stored on your tablet, Laptop or PC as a record of the status of the installation.

For more information on this feature please contact us directly.

3. Monitoring (Buddy System)

The Ei3000MRF SmartLINK Module facilitates a simple monitoring or buddy system between the Alarms. The system must first be successfully house coded. Then to enable Monitoring, hold the House Code Button of one Alarm only until the green LED lights solid (typically takes about 12 seconds) and then release. Each Alarm will "pair" with the strongest signal than it has received during the house coding process. When successfully paired the LED will flash blue-green. If the LED flashes blue-red, then pairing has failed. Try re-orientating the Alarm heads or adding extra RF devices to improve the range. Then re-house code the system and re-start the monitoring process again. To exit Monitoring mode, hold the House Code Button until the green LED lights solid and then release. Alternatively, it will automatically exit monitoring mode after 30 minutes.

Monitoring is now enabled in the network. If a paired Alarm then loses the signal from its buddy, it will flash red-blue for 10 minutes (this can also be seen after a button test).

To disable monitoring, hold the House Code Button until the red LED lights solid and then release. Note: A monitoring failure does not necessarily mean that the RF signal cannot be propagated through the RF mesh network. Multiple path communication, via the mesh architecture, ensures that the signal could be propagated through alternative signal paths to ensure the required communication.

4. Smart Sound Pattern

When installed as part of a RF interconnected system of Ei3000 series CO and fire alarms only, all devices will sound using the appropriate alarm sound pattern for the alarm event detected. For example, if a CO detection triggered the alarm, then all Ei3000 RF

interconnected devices will sound with the CO sound pattern. Similarly, if fire was detected, then all devices will sound with the fire sound pattern. This feature is not available for hardwired, mixed or hybrid installations.









5. Live Monitoring



The Ei3000MRF SmartLINK Module, together with the Ei1000G Gateway and the proprietary Cloud portal, delivers a unique "live monitoring" of the installation.













For more information on this feature please contact us directly.

5

Troubleshooting and Indicator summary tables

Normal Operation				
Mode	Blue LED	Red LED	Green LED	Sound
Power Up	 x 1	 x 1	 x 1	—
Standby	—	—	—	—
Button Test	 x 1	—	—	
Alarm	 x 1 followed by flash every 10 Sec	—	—	
Head Removal	 x 1 followed by flash 1 minute later	—	—	—

 = LED on solid  = LED flashing

RF Mode				
Mode	Button Action	Blue LED	Red LED	Green LED
House Code enter	Press and release on solid blue		—	—
In house code	—		—	—
House code exit	Press and release on solid blue		—	—
Factory reset	Press and release on flashing blue		—	—
Remote learn entry	Press and release on multi-colour flashing		—	—
Enable Monitoring	Press and release on solid green	—	—	
In monitoring (paired)	—		—	
In monitoring (failed)	—			—
Monitoring mode exit	Press and release on solid green	—	—	
Disable Monitoring	Press and release on solid red	—		—

Fault Conditions

What you see / hear

Red LED	Sound	What it means	What to do
—	Rapid Beeping	Incompatible house code	Factory reset the module and re-try
 rapidly after button release	—	Communication failure between module and Alarm head	Remove the module, re-seat and re-try

5.1. Normal Operation

5.1.1. Power Up

With the RF module fitted, slide the Alarm onto the base to power up. The red LED will flash once followed by one flash of the blue LED and then one flash of the green LED to indicate that RF module has been powered successfully. The Alarm head will also activate its power on sequence of LEDs.

5.1.2. Standby

In standby mode there are no active visible or audible indications which can be intrusive to the householder. To confirm that the Alarm is operational perform a weekly button test.

5.1.3. Monthly button test

Press and hold the test button. The Alarm will sound and the blue LED will light for 3.5 seconds to indicate RF transmission of the test message.

5.1.4. Sensing Fire/CO

As soon as the Alarm senses fire and/or dangerous levels of CO it will go into alarm (along with any interconnected Alarms). The blue LED will light for 3.5 seconds to indicate RF transmission of the fire message. It will continue to flash every 10 seconds while the alarm condition remains.

5.1.5. Alarm Head removal

Once the Alarm head is removed from the mounting plate, the blue LED will light for 3.5 seconds to indicate RF transmission of the head removal message. This will be repeated 1 minute later.

5.2 Module Status

5.2.1 House Code

To enter house code mode, hold the House Code Button until the blue LED lights solid and then release. The blue led will then flash rapidly for a few seconds to indicate the module is in house code mode. The blue led will then flash every 5 seconds for each house code serial number that it learns.

To exit house code mode, hold the House Code Button until the blue LED lights and then release. The module will then transmit a learn exit message (3.5 second blue flash). Alternatively, the module will exit house code mode after 30 minutes.

5.2.2 Factory Reset

To factory reset the module, hold the House Code Button until the blue LED flashes and then release. The blue LED will then flash rapidly for a few seconds to indicate a successful reset followed by a single blue flash.

5.2.3 Remote Learn Entry

To activate remote learn entry, hold the House Code Button until the LED flashes red-blue-green and then release. The blue LED will then flash rapidly for a few seconds to indicate the mode activation, followed by a 3.5 second blue flash. Remote learn entry is only possible if successful house coding has been previously completed.

5.2.4 Monitoring

Monitoring is only possible if successful house coding has been previously completed and should only be initiated on one device in the network.

To enable Monitoring, hold the House Code Button until the green LED lights solid and then

release. The green led will then flash rapidly for a few seconds to indicate the module is in monitoring mode. It will then flash the green led every 5 seconds until, if successful, when it will flash blue-green, or if failed to buddy, it will flash blue-red. If the buddy process has failed, try re-orientating the Alarm heads or adding extra RF devices to improve the range. Then re-house code the system and re-start the monitoring process again. To exit Monitoring mode, hold the House Code Button until the green LED lights solid and then release. It will then transmit an exit signal indicated by a green flash. Monitoring is now enabled in the network. To disable monitoring, hold the House Code Button until the red LED lights solid and then release. It will then transmit an exit signal indicated by a red flash. Monitoring is now disabled in the network.

5.3 Fault Conditions

5.3.1. Incompatible House coding

This can occur if a previously house coded module has been swapped from one Alarm head to another. In this case the module will determine if the correct coding is compatible with the new Alarm head, if not, this is indicated to the installer by the Alarm head beeping rapidly for 10 minutes and thereafter every 10 seconds. This error can be rectified by factory resetting the module.

5.3.2 Failure in Communication between Module and Alarm head

When entering house code mode, the module checks if the head type has been determined and will allow house code entry if the head type is known. If the head type is not determined, then the module's red LED will flash rapidly for a few seconds after release of the button. The module will not enter house code mode. To rectify, remove the module from the Alarm head and then re-try again. If it fails the second time, then contact us for further details.

6

Testing the System

Check that the green light is on continuously to indicate that mains power is present.

Frequent testing of the system is a requirement to ensure its continued and safe operation. Guidelines and best practices for testing are as follows:

1. After the system is installed.
2. Regularly (monthly testing is recommended).
3. After prolonged absence from the dwelling (e.g. after holiday period).
4. After repair or servicing of any of the systems elements or household electrical works.
5. After renovations to the house.

To test an individual Alarm press and hold the test button until the horn sounds and the green or red light flashes.

This will ensure that the sensor, electronics and sounder are working.

To test the SmartLINK system, press and hold the test button on one of the Alarms. The blue LED from the Ei3000MRF will illuminate for approximately 3.5 seconds. Continue to hold the test button until all the Alarms in the system are sounding. This will take between 20 to 45 seconds depending on the number of Alarms and their locations in the system, e.g. a system with 12 Alarms may take up to 45 seconds for all to sound. Release the test button when the test is completed.

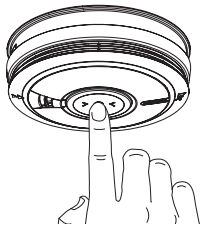
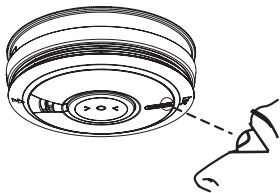

The local Alarm will stop sounding but you will hear the other Alarms still sounding in the distance.

Switching off Mains for long periods

If the premises are regularly being left without mains power for long periods the Alarms should be removed from their mounting plates and the Ei3000MRF modules (if fitted) should be removed to prevent the batteries becoming fully depleted. (This is sometimes done with holiday homes which are only occupied in the summer).

End of Life (EOL) Check

Once the Alarm passes its 10th year of installation, it will give 3 short chirps with 3 yellow LED flashes every 48 seconds to indicate it has reached its end of useful life.

Check the 'replace by date' label on all Ei3000MRF modules. If the date has been exceeded then the module should be replaced.

7

Interconnected CO Alarms and Smoke Alarms

Identifying source of Alarm

Ei Electronics Carbon Monoxide Alarms, Smoke Alarms, Heat Alarms or Dual Sensor Alarms can be interconnected via RadioLINK, RadioLINK+ or SmartLINK so that one Alarm sensing danger will cause all the other units to sound, enabling the alarm to be heard throughout the residence.

When a system alarms, check to see which unit has its red light flashing rapidly - this is the source of the alarm.

If it is a Carbon Monoxide Alarm, ventilate the residence and follow the instructions in the Carbon Monoxide Alarm manual.

If it is a Smoke or Heat Alarm, evacuate the residence and follow the instructions in the Smoke Alarm manual.

For added convenience we recommend that an Ei450 Alarm Controller is used with these RF systems. When there is an alarm, an icon on the Ei450 Alarm Controller shows if it is a CO or Fire incident and can be remotely controlled accordingly.

8

SmartLINK Troubleshooting

It is important that all Alarms in your system communicate with each other. The number of walls, ceilings and metal objects in the signal path will reduce the strength of the SmartLINK signals between the Alarms. Accordingly, one or more Smoke/Heat/CO Alarms may have difficulties in communicating to all the other Alarms in the system.

If, when checking the SmartLINK interconnection, some of the Alarms do not respond to the button test, then you will need to either:

- (i) Position another SmartLINK Alarm to act as a 'repeater' between the Alarms which are not communicating and so shorten the path and/or by-pass an obstacle which is blocking the signal. When the new Alarm is fitted, House Code all Alarms again, as described above.
- (ii) rotate / re-locate the Alarms (e.g. move them away from metal surfaces or wiring).

After making these changes to the RF signal path, the SmartLINK signals may still not be reaching all the Alarms in your system, even though they have already been House Coded successfully (see Section on "Limitations of Radio Communications").

It is important to check that all Alarms are communicating in their final installed positions. If Alarms are rotated, have had their antennas extended and/or re-sited, we would recommend that all the Alarms are returned to the factory settings and then House Coded again in their final positions (see above). The SmartLINK interconnection should then be checked again by button testing all units.

(NB. The SmartLINK module can be returned to the original factory settings by pressing and holding the House Code Button until the blue light turns on solidly and then flashes rapidly. This will take about 7 seconds. This clears the learnt House Codes).

9

Technical Specifications

Power Supply:	Powered by Alarm head unit
RF Range:	A minimum of 100 metres in free space
RF Visual Indicator:	Blue light flashes continuously for 0.5 to 3.5 seconds while transmitting RF signal
RF Frequency:	868.499MHz (1% duty cycle)
Max RF Power:	+6dBm
Dimensions:	80mm length x 19mm depth x 16mm height
Temperature Range:	-10° to 40°C
Humidity Range:	15% to 95% Relative Humidity
Interconnect*:	Up to 12 SmartLINK modules
Optional Accessories:	Ei407 Manual Call Point, Ei428 Relay Module ,Ei414 Fire / CO Alarm Interface, Ei450 RadiolINK Alarm Controller
Approvals:	RF performance to EN 300 220-1 in accordance with EN 300 220-2 EMC performance to EN 301 489-1 in accordance with EN 301 489-3 RF Safety to EN62479

* We recommend, for ease of installation and RF communication, that up to 12 RF devices can be installed in any one RF coded system. Please contact us for further advice if additional RF devices are required.

10

Guarantee

Ei Electronics guarantees this RF SmartLINK Module for five years from date of purchase against any defects that are due to faulty materials or workmanship. This guarantee only applies to normal conditions of use and service, and does not include damage resulting from accident, neglect, misuse, unauthorised dismantling, or contamination howsoever caused. This guarantee excludes incidental and consequential damage. If this RF SmartLINK Module should become defective within the guarantee period, it must be returned to Ei Electronics, with proof of purchase, carefully packaged and with the problem clearly stated. We shall at our discretion repair or replace the faulty unit.

Do not interfere with the Alarm or attempt to tamper with it. This will invalidate the guarantee, but more importantly may expose the user to shock or fire hazards. This guarantee is in addition to your statutory rights as a consumer.

11

Limitations of Radio Communications

Ei Electronics radio communication systems are very reliable and are tested to high standards. However, due to their low transmitting power and limited range (required by regulatory bodies) there are some limitations to be considered:

(i) Receivers may be blocked by radio signals occurring on or near their operating frequencies, regardless of the House Coding.

(ii) Alarms with SmartLINK modules should be tested regularly, at least weekly. This is to determine whether there are sources of interference preventing communication, that the radio paths have not been disrupted by moving furniture or renovations, and if so, to give a warning of these and other faults.



Hereby, Ei Electronics declares that this Ei3000MRF SmartLINK Module is in compliance with the essential requirements and other relevant provisions of Directive 2014/53/EU. The Declaration of Conformity may be consulted at www.eielectronics.com/compliance

The crossed out wheellie bin symbol that is on your product indicates that this product should not be disposed of via the normal household waste stream. Proper disposal will prevent possible harm to the environment or to human health. When disposing of this product please separate it from other waste streams to ensure that it can be recycled in an environmentally sound manner. For more details on collection and proper disposal, please contact your local government office or the retailer where you purchased this product.





P/N B19047 Rev2

© Ei Electronics 2019

Aico Ltd. Mile End Business Park,
Maesbury Rd, Oswestry, Shropshire SY10 8NR, U.K.

Tel: 01691 664100

www.aico.co.uk

Ei Electronics. Shannon, Co Clare, Ireland.

Tel:+353 (0)61 471277

www.eielectronics.com